

MINICONTADOR MODELO EM-2010

MINICOUNTER EM-2010

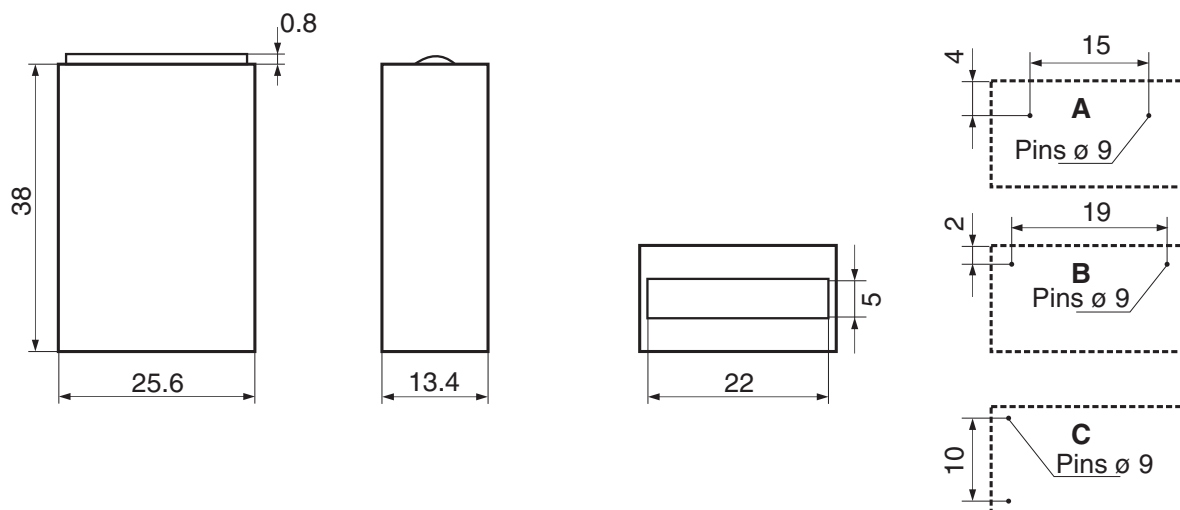
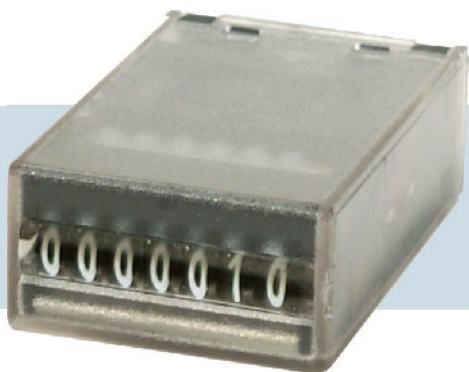

Características Técnicas:

Nº de cifras:	7 (op. 3,4,5,6)	Ciclo:	50% Imp./pausa
Alt. cifras:	visual 4x1.75 mm	Velocidad máx.:	15 imp./seg.
Conexión:	Pins y cables	Wattios:	0,1 - 0,4 W
Voltaje:	4,5-5-6-12-24 VDC	Prueba:	5000 imp a 15 imp/seg
Diodo:	Opcional	Peso:	15 g
Tolerancia:	-5% + 30%		

Technical Specifications:

Figures:	7 (op. 3,4,5,6)	Cicle:	50% Coup/pause
Size of figures:	view 4x1.75 mm	Máx. speed:	15 c.p.s.
Connection:	Pins and Flying Leads	Consumption:	0,1 - 0,4 W
Voltage:	4,5-5-6-12-24 VDC	Test:	5000 c at 15 c.p.s.
Diode:	Optional	Weight:	15 g
Tolerance:	-5% +30%		

CONSTRUCCIÓN:

Ruedas, piñones y leva: Resina Acetálica.
Tapa: Policarbonato Transparente.
Chasis: Resina Acetálica.
Pins y Fastons: Latón con baño de plata.
Ejes: Acero Inoxidable AISI-304.

APLICACIONES:

Circuito Impreso.

CONSTRUCTION:

Wheels, pinions and lever: Acetalic Resin.
Cover: Transparent Polycarbonate.
Metallic Chassis: Acetalic Resin.
Pins and Fastons: Silver plated.
Axis: Stainless Steel AISI-304.

APPLICATIONS:

Panel Board.



TALLERES EMIT, S.A.
Polígono Industrial "Can Mascaró"
Carrer Ponent, 68 · 08756 LA PALMA DE CERVELLÓ
(Barcelona - SPAIN)
Tel.: +34.902.10.71.69 Fax: +34.902.10.71.68

www.talleres-emit.com
administracion@talleres-emit.com

